

6FM65E-X 12V 65Ah(10hr)

MAINTENANCE-FREE
RECHARGEABLE
SEALED LEAD ACID BATTERY

The rechargeable batteries are lead-lead dioxide systems. The dilute sulfuric acid electrolyte is absorbed by separators and plates and thus immobilized. Should the battery be accidentally overcharged producing hydrogen and oxygen, special one-way valves allow the gases to escape thus avoiding excessive pressure build-up. Otherwise, the battery is completely sealed and is, therefore, maintenance-free, leak proof and usable in any position.

Battery Construction

Component	Positive plate	Negative plate	Container	Cover	Safety valve	Terminal	Separator	Electrolyte
Raw material	Lead dioxide	Lead	ABS	ABS	Rubber	Copper	Fiberglass	Sulfuric acid

General Features

- Absorbent Glass Mat (AGM) technology for efficient gas recombination of up to 99% and freedom from electrolyte maintenance or water adding.
- Not restricted for air transport-complies with IATA/ICAO Special Provision A67.
- UL-recognized component.
- Can be mounted in any orientation.
- Computer designed lead, calcium tin alloy grid for high power density.
- Long service life, float or cyclic applications.
- Maintenance-free operation.
- Low self discharge.

Dimensions and Weight

Length(mm / inch)	350 / 13.8
Width(mm / inch)	167 / 6.57
Height(mm / inch)	179 / 7.05
Total Height(mm / inch)	179 / 7.05
Approx. Weight(Kg / lbs)	22.4 / 49.4

* Weight deviation: ± 3%

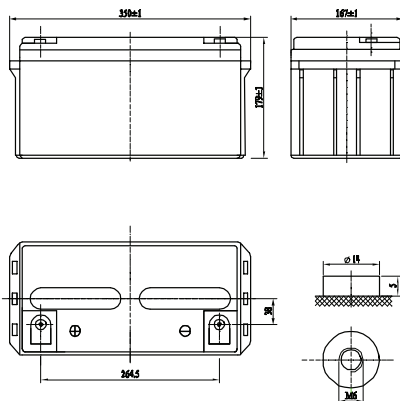

Performance Characteristics

Nominal Voltage	12V
Number of cell	6
Design Life	10 years
Nominal Capacity 77°F(25°C)	
10 hour rate (6.5,10.8V)	65Ah
5 hour rate (10.8A, 10.5V)	54Ah
1 hour rate (43.1A, 9.6V)	43.1Ah
Internal Resistance	
Fully Charged battery 77°F(25°C)	≤6.8mOhms
Self-Discharge	
3% of capacity declined per month at 20°C(average)	
Operating Temperature Range	
Discharge	-20~60°C
Charge	-10~60°C
Storage	-20~60°C
Max. Discharge Current 77°F(25°C)	650A(5s)
Short Circuit Current	1700A
Charge Methods: Constant Voltage Charge 77°F(25°C)	
Cycle use	2.40-2.45VPC
Maximum charging current	19.5A
Temperature compensation	-30mV/°C
Standby use	2.20-2.28VPC
Temperature compensation	-20mV/°C

Discharge Constant Current (Amperes at 77 °F25°C)

End Point Volts/Cell	5min	10min	15min	30min	1h	3h	5h	10h	20h
1.60V	207	154	121	68.4	43.1	16.9	11.5	6.58	3.48
1.65V	196	149	116	66.3	42.0	16.5	11.2	6.56	3.46
1.70V	184	138	110	64.3	41.0	16.1	11.0	6.54	3.43
1.75V	172	127	104	62.2	39.9	15.7	10.8	6.52	3.40
1.80V	159	116	96.5	59.9	39.0	15.4	10.6	6.50	3.36

Discharge Constant Power (Watts at 77 °F25°C)

End Point Volts/Cell	5min	10min	15min	30min	45min	1h	2h	3h	5h
1.60V	368	272	197	119	95.1	78.8	47.5	33.8	22.5
1.65V	346	258	193	118	93.6	77.0	46.5	33.1	22.3
1.70V	325	243	190	117	91.7	75.3	45.5	32.4	21.8
1.75V	304	229	186	114	89.6	73.5	44.5	31.8	21.6
1.80V	292	212	177	112	87.3	72.7	43.3	31.1	21.4

(Note)The above characteristics data are average values obtained within three charge/discharge cycles not the minimum values.
All data shall be changed without notice,AMB reserves the right to explain and update the information contained hereinto.

6FM65E-X 12V 65Ah(10hr)

MAINTENANCE-FREE
RECHARGEABLE
SEALED LEAD ACID BATTERY

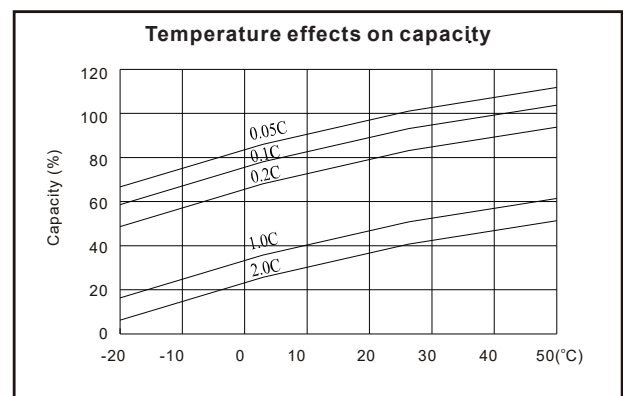
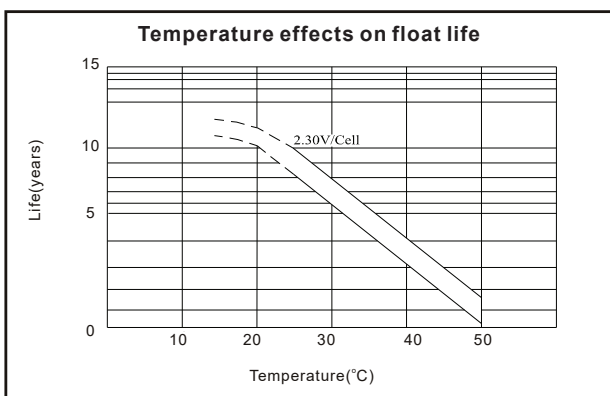
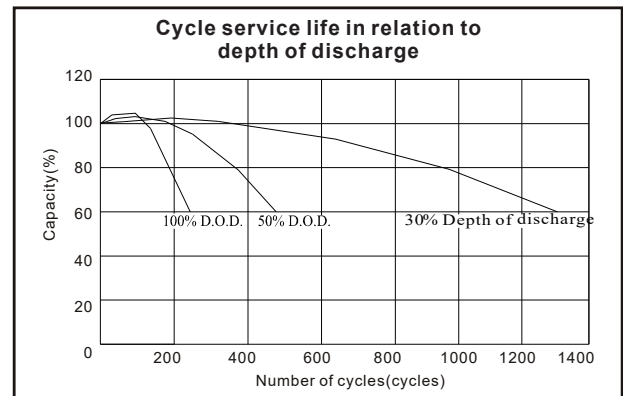
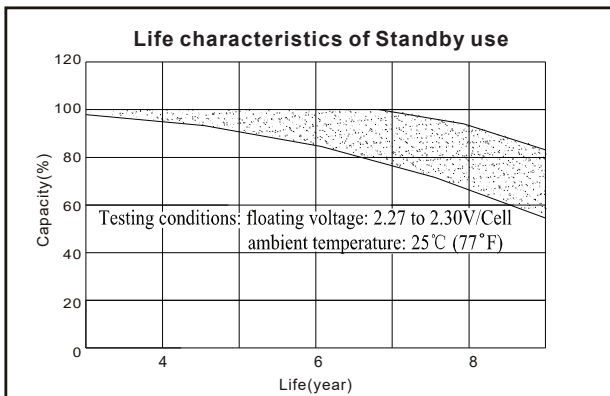
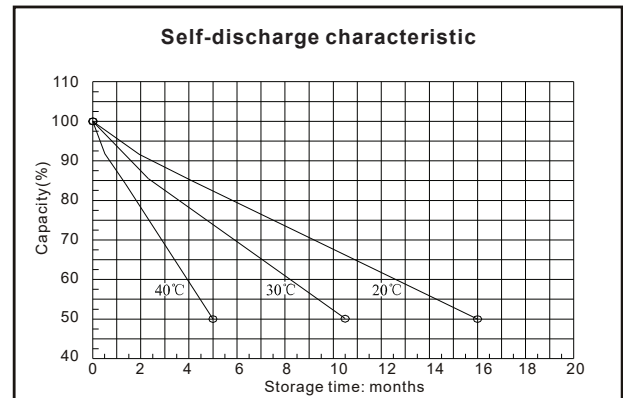
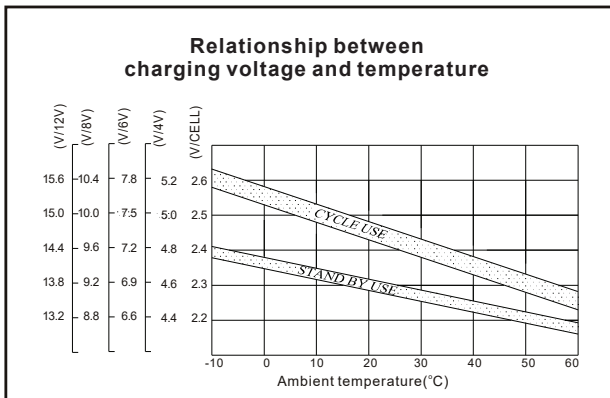
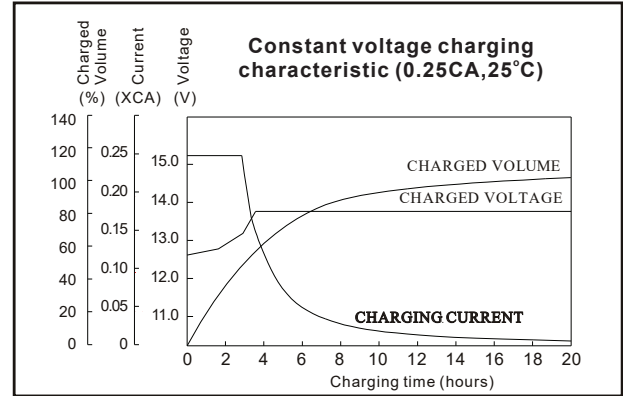
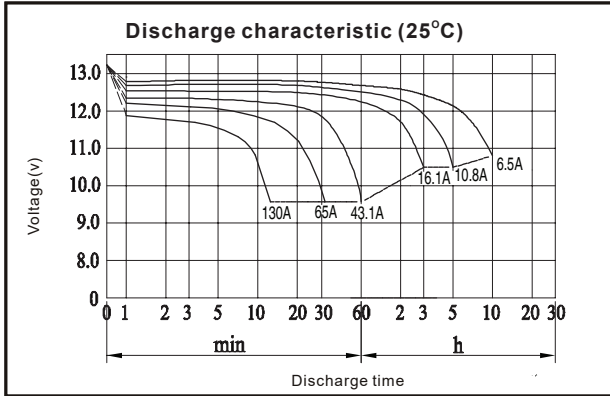

6FM100E-X 12V 100Ah(10hr)

MAINTENANCE-FREE
RECHARGEABLE
SEALED LEAD ACID BATTERY

The rechargeable batteries are lead-lead dioxide systems. The dilute sulfuric acid electrolyte is absorbed by separators and plates and thus immobilized. Should the battery be accidentally overcharged producing hydrogen and oxygen, special oneway valves allow the gases to escape thus avoiding excessive pressure build-up. Otherwise, the battery is completely sealed and is, therefore, maintenance-free, leak proof and usable in any position.

Battery Construction

Component	Positive plate	Negative plate	Container	Cover	Safety valve	Terminal	Separator	Electrolyte
Raw material	Lead dioxide	Lead	ABS	ABS	Rubber	Copper	Fiberglass	Sulfuric acid

General Features

- Absorbent Glass Mat (AGM) technology for efficient gas recombination of up to 99% and freedom from electrolyte maintenance or water adding.
- Not restricted for air transport-complies with IATA/ICAO Special Provision A67.
- UL-recognized component.
- Can be mounted in any orientation.
- Computer designed lead, calcium tin alloy grid for high power density.
- Long service life, float or cyclic applications.
- Maintenance-free operation.
- Low self discharge.

Dimensions and Weight

Length(mm / inch)	330 / 12.99
Width(mm / inch)	171 / 6.73
Height(mm / inch)	215 / 8.46
Total Height(mm / inch)	222 / 8.74
Approx. Weight(Kg / lbs)	29 / 63.9

* Weight deviation: ± 3%

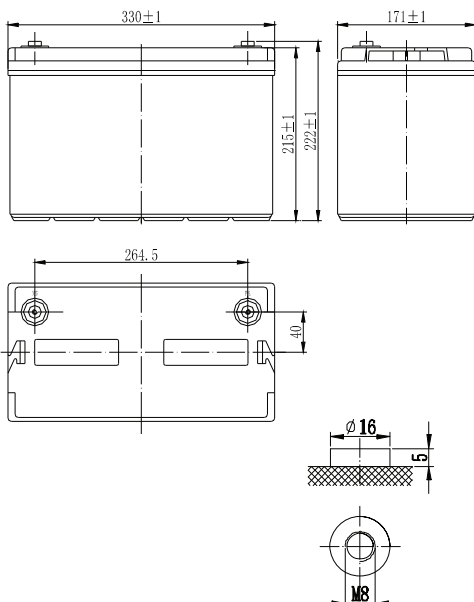

Performance Characteristics

Nominal Voltage	12V
Number of cell	6
Design Life	10 years
Nominal Capacity 77°F(25°C)	
10 hour rate (10.0A, 10.8V)	100Ah
5 hour rate (16.6A, 10.5V)	83Ah
1 hour rate (61A, 9.6V)	61Ah
Internal Resistance	
Fully Charged battery 77°F(25°C)	≤ 5.7mOhms
Self-Discharge	
3% of capacity declined per month at 20°C(average)	
Operating Temperature Range	
Discharge	-20~60°C
Charge	-10~60°C
Storage	-20~60°C
Max. Discharge Current 77°F(25°C)	900A(5s)
Short Circuit Current	2100A
Charge Methods: Constant Voltage Charge 77°F(25°C)	
Cycle use	2.40-2.45VPC
Maximum charging current	30A
Temperature compensation	-30mV/°C
Standby use	2.20-2.28VPC
Temperature compensation	-20mV/°C

Discharge Constant Current (Amperes at 77°F25°C)

End Point Volts/Cell	10min	15min	30min	1h	3h	5h	10h	20h
1.60V	210	173	98.9	61.0	25.1	17.6	10.8	5.50
1.65V	197	164	95.0	60.6	24.6	17.3	10.6	5.45
1.70V	182	156	92.2	59.7	24.1	17.0	10.4	5.40
1.75V	170	145	89.3	58.9	23.5	16.6	10.2	5.35
1.80V	156	136	87.4	57.1	22.8	16.3	10.0	5.30

Discharge Constant Power (Watts at 77°F25°C)

End Point Volts/Cell	10min	15min	30min	45min	1h	2h	3h	5h
1.60V	372	304	186	138	119	68.2	48.4	33.8
1.65V	353	299	180	134	117	67.0	47.8	33.6
1.70V	335	290	176	132	116	65.8	47.3	33.3
1.75V	317	279	170	129	112	64.6	46.7	33.2
1.80V	296	270	164	126	109	63.9	45.9	32.9

(Note)The above characteristics data are average values obtained within three charge/discharge cycles not the minimum values. All data shall be changed without notice,AMB reserves the right to explain and update the information contained hereinto.

6FM100E-X 12V 100Ah(10hr)

MAINTENANCE-FREE
RECHARGEABLE
SEALED LEAD ACID BATTERY

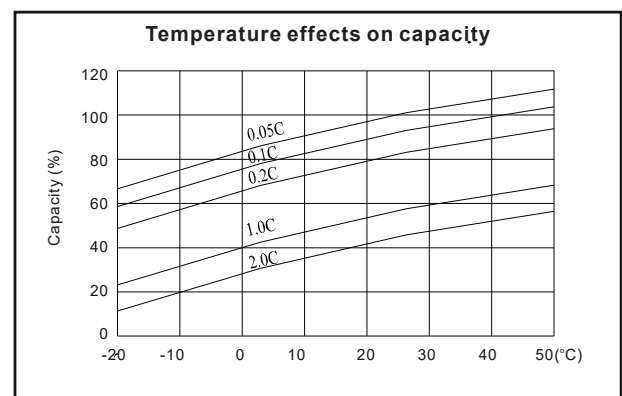
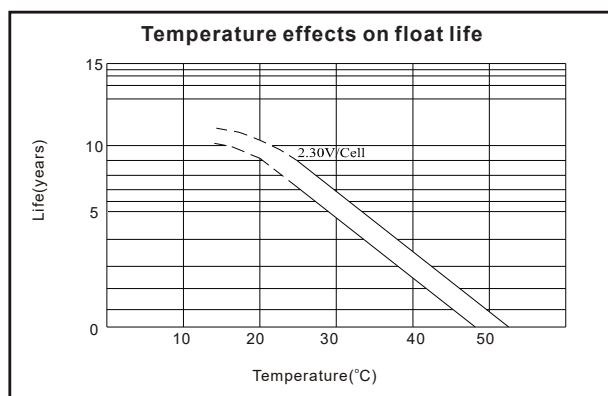
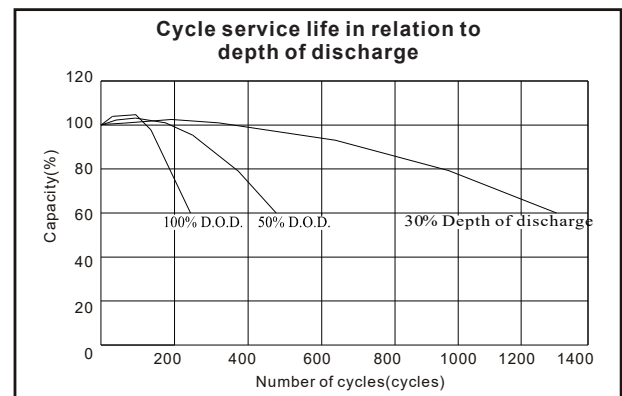
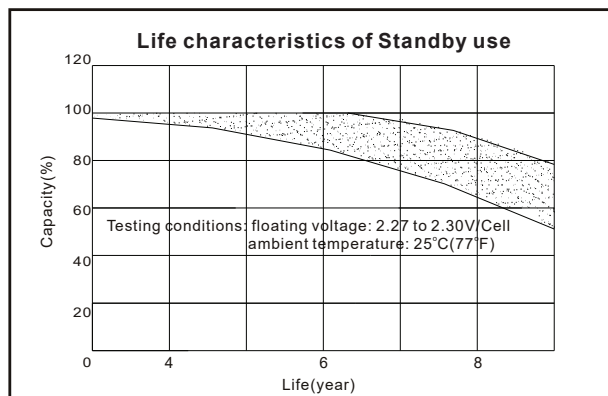
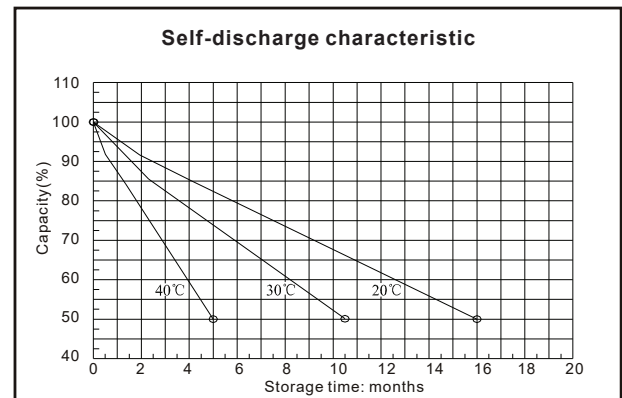
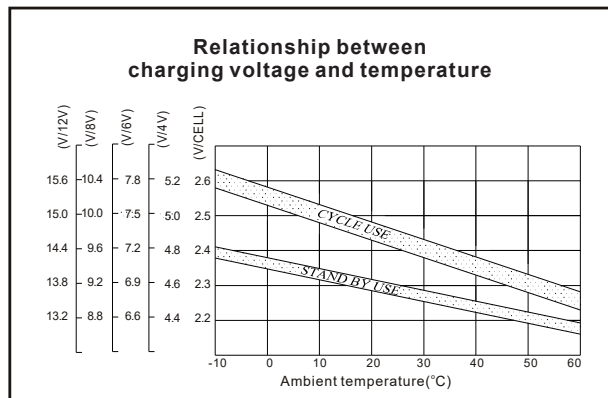
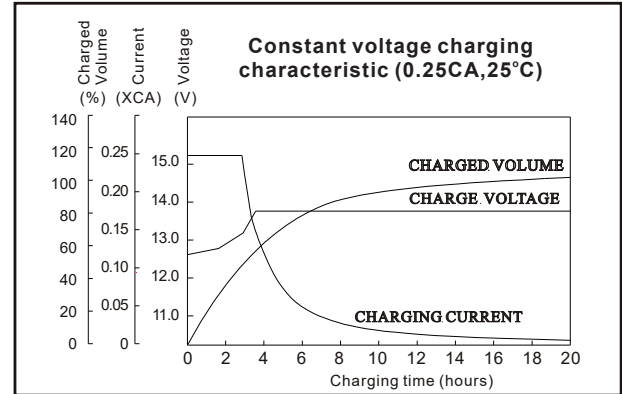
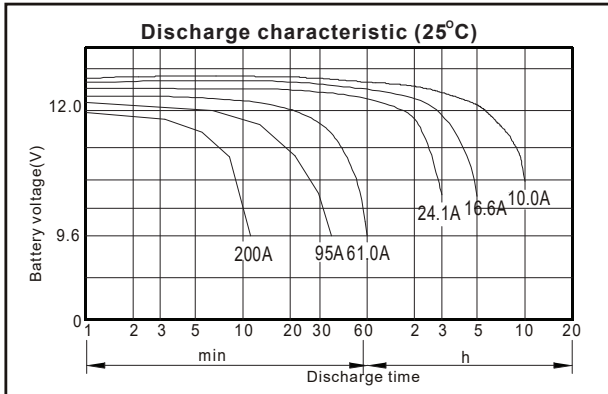

6FM150M-X 12V 150Ah(10hr)

MAINTENANCE-FREE
RECHARGEABLE
SEALED LEAD ACID BATTERY

Overview

The rechargeable batteries are lead-lead dioxide systems. The dilute sulfuric acid electrolyte is absorbed by separators and plates and thus immobilized. Should the battery be accidentally overcharged producing hydrogen and oxygen, special oneway valves allow the gases to escape thus avoiding excessive pressure build-up. Otherwise, the battery is completely sealed and is, therefore, maintenance-free, leak proof and usable in any position.

Battery Construction

Component	Positive plate	Negative plate	Container	Cover	Safety valve	Terminal	Separator	Electrolyte
Raw material	Lead dioxide	Lead	ABS	ABS	Rubber	Copper	Fiberglass	Sulfuric acid

General Features

- Absorbent Glass Mat (AGM) technology for efficient gas recombination of up to 99% and freedom from electrolyte maintenance or water adding.
- Not restricted for air transport-complies with IATA/ICAO Special Provision A67.
- UL-recognized component.
- Can be mounted in any orientation.
- Computer designed lead, calcium tin alloy grid for high power density.
- Long service life, float or cyclic applications.
- Maintenance-free operation.
- Low self discharge.
- Case and cover available in both standard and flame retardant ABS.

Dimensions and Weight

Length(mm / inch)	482 / 19.0
Width(mm / inch)	170 / 6.69
Height(mm / inch)	240 / 9.45
Total Height(mm / inch)	240 / 9.45
Approx. Weight(Kg / lbs)	42.5 / 93.7

* Weight deviation: ± 5%

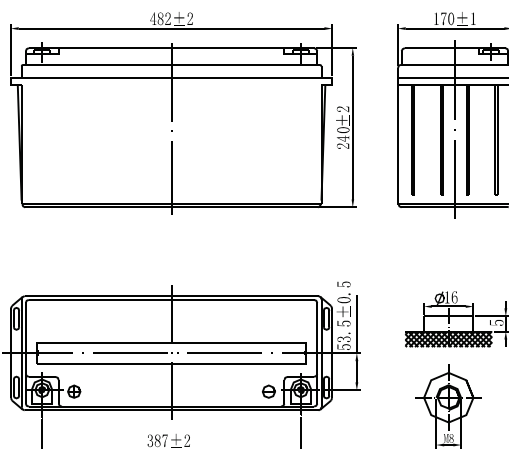

Battery Specification

Performance Characteristics

Nominal Voltage	12V
Number of cell	6
Design Life	10 years
Nominal Capacity 77°F(25°C)	
10 hour rate (15.3A, 10.8V)	153Ah
5 hour rate (26.7A, 10.5V)	133.5Ah
1 hour rate (98.6A, 9.6V)	98.6Ah
Internal Resistance	
Fully Charged battery 77°F(25°C)	≤4.0mOhms
Self-Discharge	
3% of capacity declined per month at 20°C(average)	
Operating Temperature Range	
Discharge	-20~60°C
Charge	-10~60°C
Storage	-20~60°C
Max. Discharge Current 77°F(25°C)	1000A(5s)
Short Circuit Current	2800A
Charge Methods: Constant Voltage Charge 77°F(25°C)	
Cycle use	2.40-2.45VPC
Maximum charging current	45.0A
Temperature compensation	-30mV/°C
Standby use	2.20-2.28VPC
Temperature compensation	-20mV/°C

Discharge Constant Current (Amperes at 77°F25°C)

End Point								
Volts/Cell	10min	15min	30min	45min	1h	3h	5h	10h
1.60V	---	---	172.5	124.1	98.6	44.7	29.1	16.1
1.65V	---	---	163.4	119.1	95.2	43.4	28.1	15.9
1.70V	---	---	154.9	116.2	92.1	41.6	27.4	15.6
1.75V	---	---	148.8	111.7	89.3	40.5	26.7	15.4
1.80V	---	---	143.3	107.7	85.3	39.8	26.0	15.3

Discharge Constant Power (Watts at 77°F25°C)

End Point								
Volts/Cell	10min	15min	30min	45min	1h	3h	5h	10h
1.60V	---	---	314.5	230.3	185.3	85.4	56.1	31.6
1.65V	---	---	300.0	222.1	179.9	83.3	54.4	31.3
1.70V	---	---	286.7	218.7	175.3	80.2	53.1	30.7
1.75V	---	---	277.0	211.1	170.5	78.2	51.9	30.4
1.80V	---	---	269.0	205.3	163.7	77.1	50.8	30.2

(Note)The above characteristics data are average values obtained within three charge/discharge cycles not the minimum values.All data shall be changed without notice, AMB reserves the right to explain and update the information contained hereinto.

6FM150M-X 12V 150Ah(10hr)

MAINTENANCE-FREE
RECHARGEABLE
SEALED LEAD ACID BATTERY

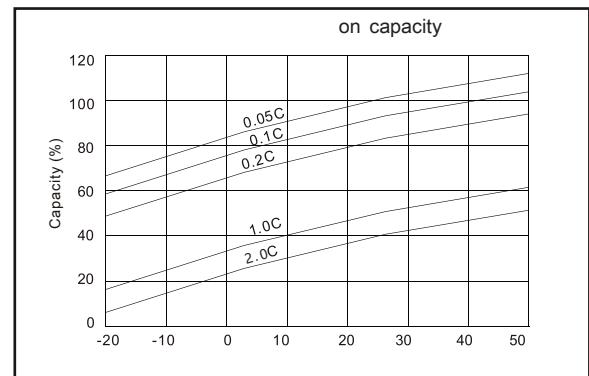
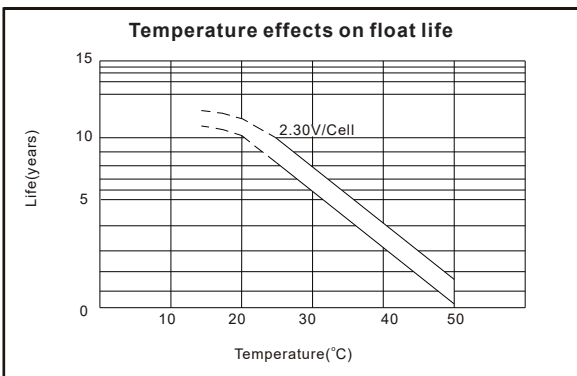
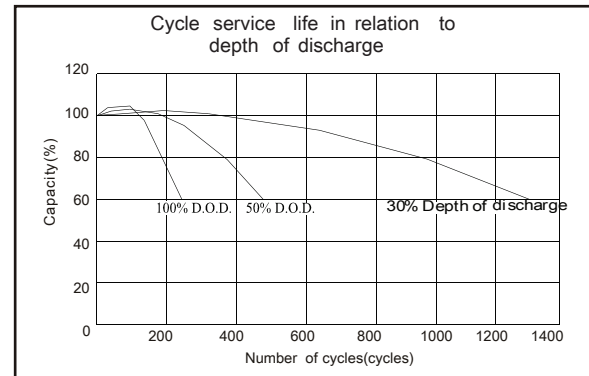
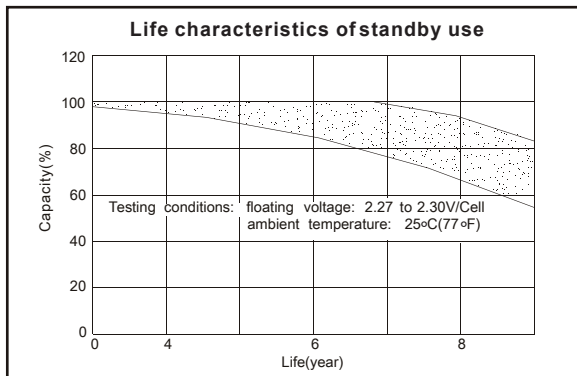
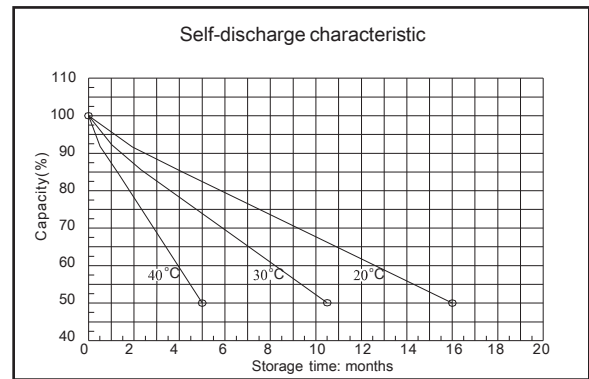
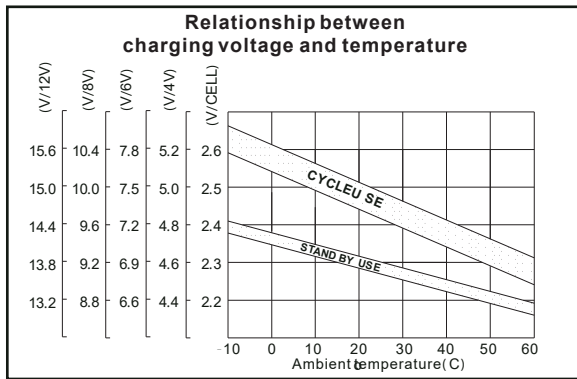
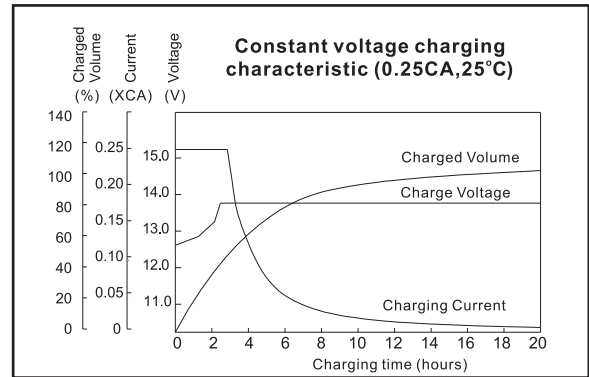
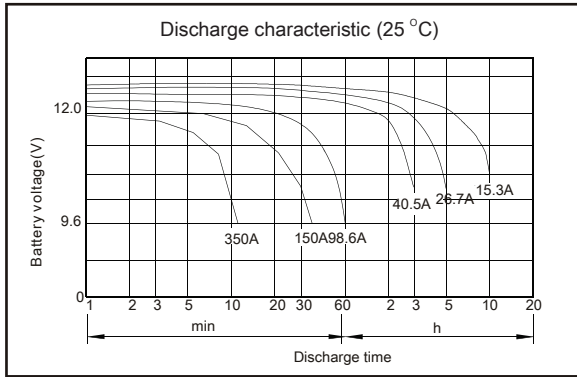

6FM150X 12V 150Ah(10hr)

MAINTENANCE-FREE
RECHARGEABLE
SEALED LEAD ACID BATTERY

The rechargeable batteries are lead-lead dioxide systems. The dilute sulfuric acid electrolyte is absorbed by separators and plates and thus immobilized. Should the battery be accidentally overcharged producing hydrogen and oxygen, special one-way valves allow the gases to escape thus avoiding excessive pressure build-up. Otherwise, the battery is completely sealed and is, therefore, maintenance-free, leak proof and usable in any position.

Battery Construction

Component	Positive plate	Negative plate	Container	Cover	Safety valve	Terminal	Separator	Electrolyte
Raw material	Lead dioxide	Lead	ABS	ABS	Rubber	Copper	Fiberglass	Sulfuric acid

General Features

- Absorbent Glass Mat (AGM) technology for efficient gas recombination of up to 99% and freedom from electrolyte maintenance or water adding.
- Not restricted for air transport-complies with IATA/ICAO Special Provision A67.
- UL-recognized component.
- Can be mounted in any orientation.
- Computer designed lead, calcium tin alloy grid for high power density.
- Long service life, float or cyclic applications.
- Maintenance-free operation.
- Low self discharge.

Dimensions and Weight

Length(mm / inch)	482±2 / 18.98±2
Width(mm / inch)	170±1 / 6.69±1
Height(mm / inch)	242±2 / 9.53±2
Total Height(mm / inch)	242±2 / 9.53±2
Approx. Weight(Kg / lbs)	47 / 103.6

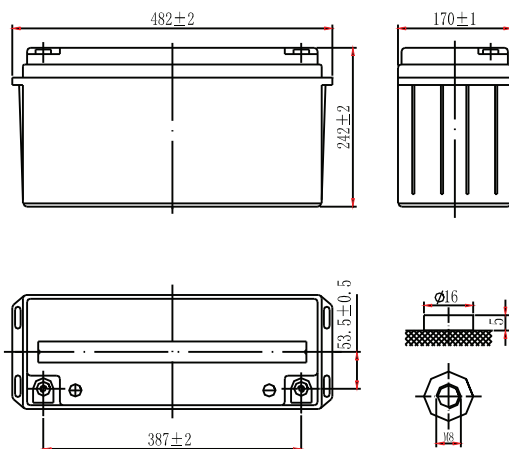

Performance Characteristics

Nominal Voltage	12V
Number of cell	6
Design Life	10 years
Nominal Capacity 77°F(25°C)	
10 hour rate (15.0A, 10.8V)	150Ah
5 hour rate (26.5A, 10.5V)	132.5Ah
1 hour rate (102A, 9.6V)	102Ah
Internal Resistance	
Fully Charged battery 77°F(25°C)	3.5mOhms
Self-Discharge	
3% of capacity declined per month at 20°C(average)	
Operating Temperature Range	
Discharge	-20~60°C
Charge	-10~60°C
Storage	-20~60°C
Max. Discharge Current 77°F(25°C)	1000A(5s)
Short Circuit Current	2800A
Charge Methods: Constant Voltage Charge 77°F(25°C)	
Cycle use	14.4-14.7V
Maximum charging current	45A
Temperature compensation	-30mV/°C
Standby use	13.6-13.8V
Temperature compensation	-20mV/°C

Discharge Constant Current (Amperes at 77°F25°C)

End Point Volts/Cell	5min	10min	15min	30min	1h	3h	5h	10h	20h
1.60V	450	351	285	165	102	41.2	28.0	15.9	8.20
1.65V	419	330	270	160	100	40.3	27.6	15.7	8.14
1.70V	388	309	256	155	98	39.5	27.1	15.5	8.08
1.75V	356	289	242	149	95	38.6	26.5	15.3	8.00
1.80V	320	266	228	146	92	37.5	26.0	15.0	7.88

Discharge Constant Power (Watts at 77°F25°C)

End Point Volts/Cell	5min	10min	15min	30min	45min	1h	2h	3h	5h
1.60V	765	609	501	325	221	201	112	78.0	53.5
1.65V	734	579	483	315	216	198	110	77.1	53.2
1.70V	686	548	465	306	211	195	108	76.2	52.8
1.75V	638	519	446	296	206	190	106	75.3	52.5
1.80V	591	487	425	286	202	184	105	74.0	52.0

(Note)The above characteristics data are average values obtained within three charge/discharge cycles not the minimum values.

6FM150X 12V 150Ah(10hr)

MAINTENANCE-FREE
RECHARGEABLE
SEALED LEAD ACID BATTERY

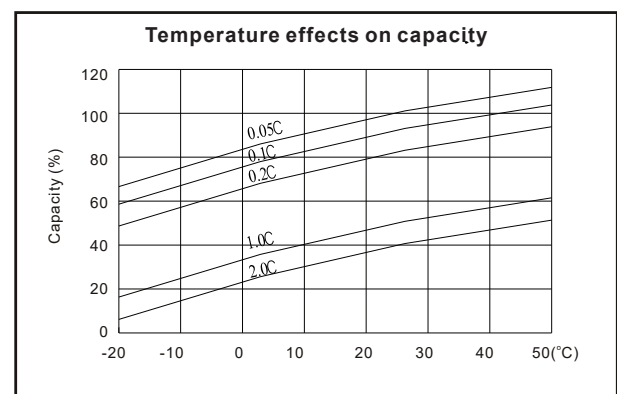
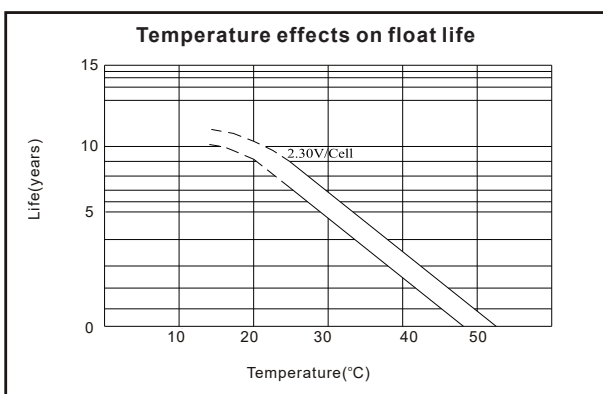
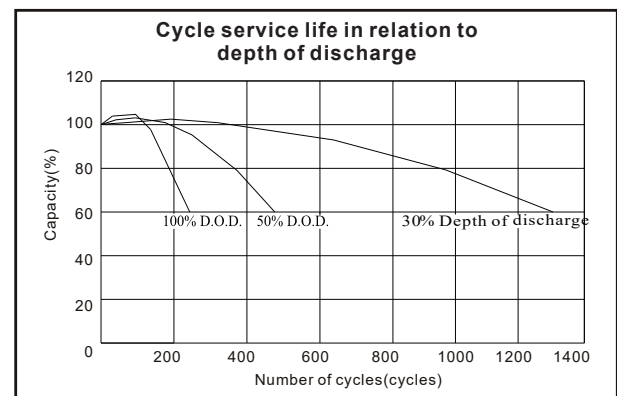
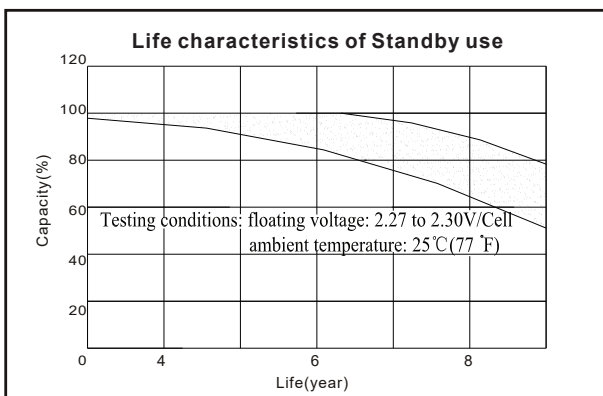
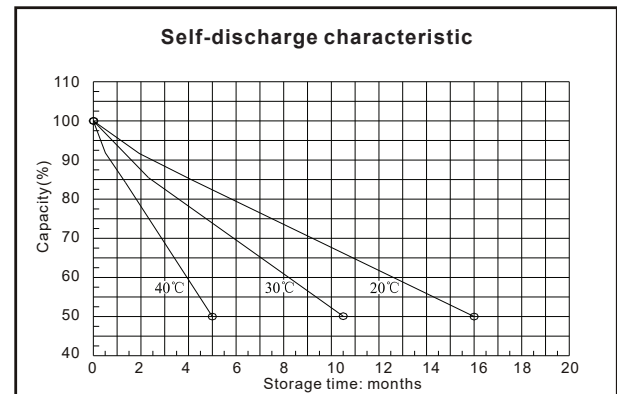
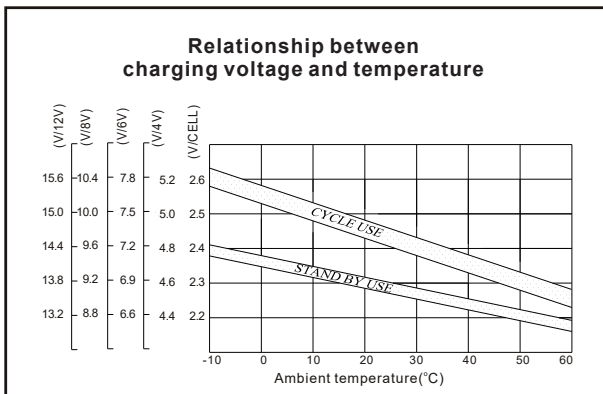
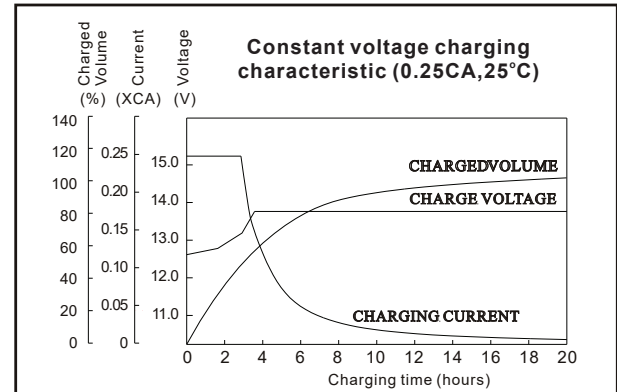
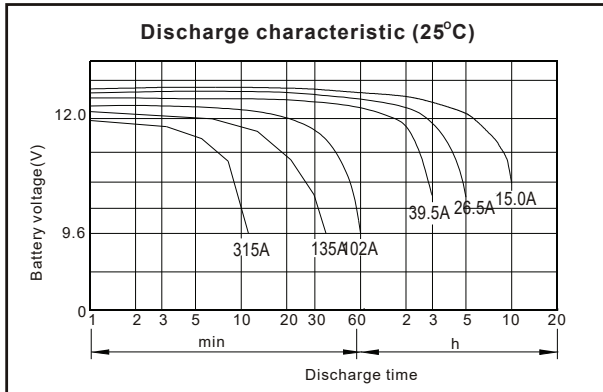

6FM200P-X 12V 200Ah(10hr)

MAINTENANCE-FREE
RECHARGEABLE
SEALED LEAD ACID BATTERY

The rechargeable batteries are lead-lead dioxide systems. The dilute sulfuric acid electrolyte is absorbed by separators and plates and thus immobilized. Should the battery be accidentally overcharged producing hydrogen and oxygen, special oneway valves allow the gases to escape thus avoiding excessive pressure build-up. Otherwise, the battery is completely sealed and is, therefore, maintenance-free, leak proof and usable in any position.

Battery Construction

Component	Positive plate	Negative plate	Container	Cover	Safety valve	Terminal	Separator	Electrolyte
Raw material	Lead dioxide	Lead	ABS	ABS	Rubber	Copper	Fiberglass	Sulfuric acid

General Features

- Advanced pure lead technology.
- Longer float & cycle life, longer warranty.
- Stronger discharge performance.
- Special design to avoid thermal runaway.
- 4-fold terminal sealing to avoid leaking.
- Excellent consistency and reliability.
- Can be mounted in any orientation.
- Maintenance-free operation.
- Low self discharge.
- Case and cover available in both standard and flame restardant ABS.

Dimensions and Weight

Length(mm / inch)	526 / 20.71
Width(mm / inch)	238 / 9.37
Height(mm / inch)	246 / 9.69
Total Height(mm / inch)	246 / 9.69
Approx. Weight(Kg / lbs)	59.5 / 131.3

* Weight deviation: $\pm 3\%$

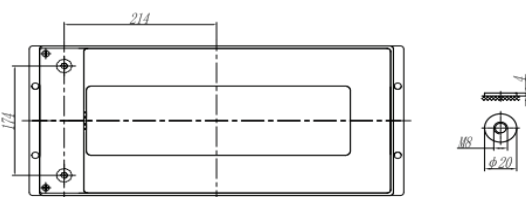
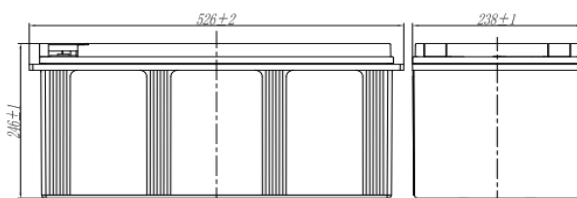

Performance Characteristics

Nominal Voltage	12V
Number of cell	6
Design Life	10 years
Nominal Capacity 77°F(25°C)	
10 hour rate (20.0A, 10.8V)	200Ah
5 hour rate (36.0A, 10.5V)	180Ah
1 hour rate (124A, 9.6V)	124Ah
Internal Resistance	
Fully Charged battery 77°F(25°C)	≤ 4.0mOhms
Self-Discharge	
3% of capacity declined per month at 20°C(average)	
Operating Temperature Range	
Discharge	-20~60°C
Charge	-10~60°C
Storage	-20~60°C
Max. Discharge Current 77°F(25°C)	1000A(5s)
Short Circuit Current	4300A
Charge Methods: Constant Voltage Charge 77°F(25°C)	
Cycle use	2.40-2.45VPC
Maximum charging current	60A
Temperature compensation	-30mV/°C
Standby use	2.20-2.30VPC
Temperature compensation	-20mV/°C

Discharge Constant Current (Amperes at 77°F25°C)

End Point Volts/Cell	5min	10min	15min	30min	45min	1h	3h	5h	10h
1.60V	564	440	360	220	159	124	57.6	38.2	20.4
1.65V	513	419	350	212	153	120	55.6	37.2	20.3
1.70V	482	400	337	206	149	117	55.0	36.6	20.2
1.75V	461	382	319	200	145	114	53.4	36.0	20.1
1.80V	428	331	269	187	140	110	51.0	35.4	20.0

Discharge Constant Power (Watts at 77°F25°C)

End Point Volts/Cell	5min	10min	15min	30min	45min	1h	3h	5h	10h
1.60V	920	756	625	402	294	230	109	73.0	40.2
1.65V	899	729	604	390	286	225	107	72.0	39.2
1.70V	857	704	586	382	279	221	105	71.2	38.4
1.75V	813	679	578	372	274	217	101	70.2	37.6
1.80V	774	644	554	364	270	215	98.0	69.3	36.7

(Note)The above characteristics data are average values obtained within three charge/discharge cycles not the minimum values.
All data shall be changed without notice,AMB reserves the right to explain and update the information contained hereinto.

6FM200P-X 12V 200Ah(10hr)

MAINTENANCE-FREE
RECHARGEABLE
SEALED LEAD ACID BATTERY

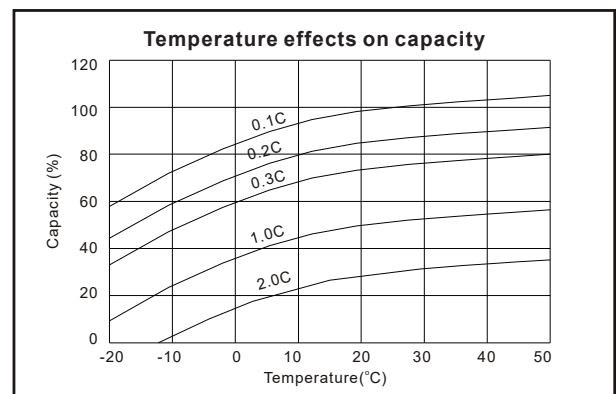
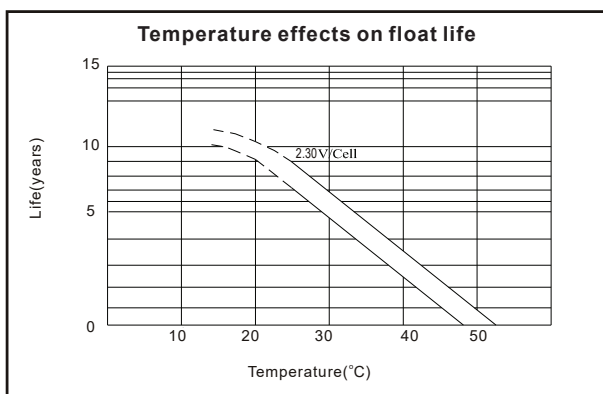
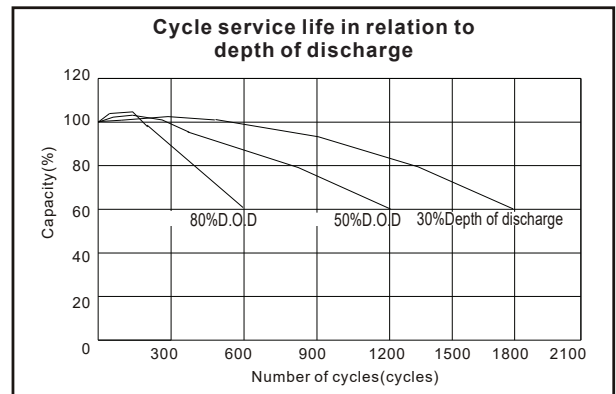
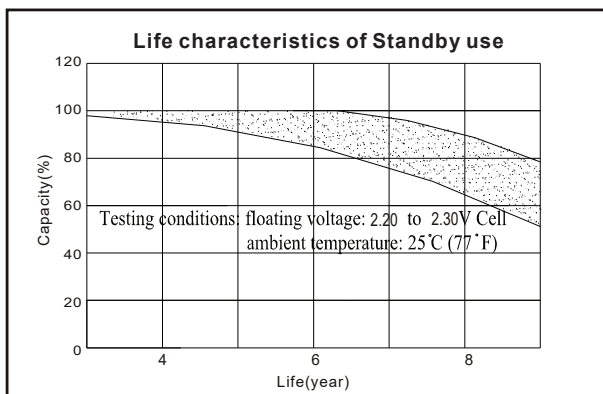
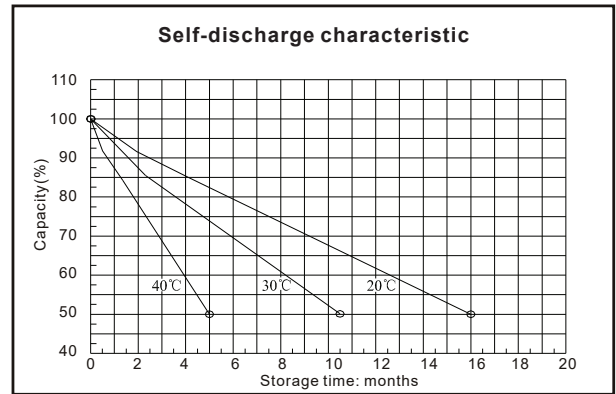
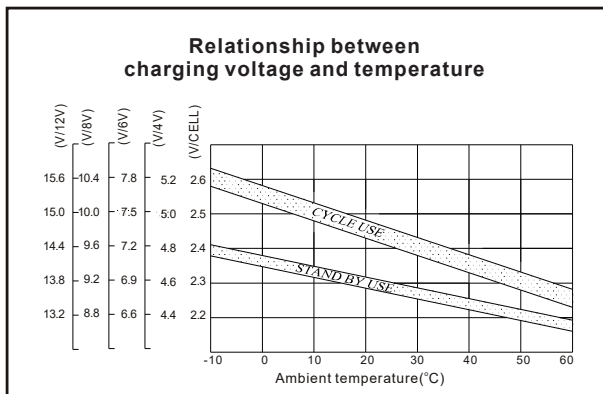
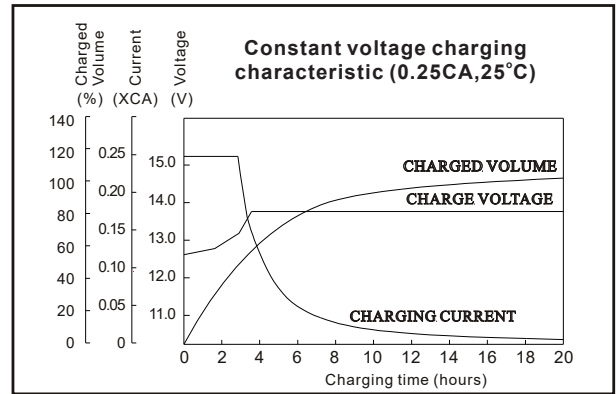
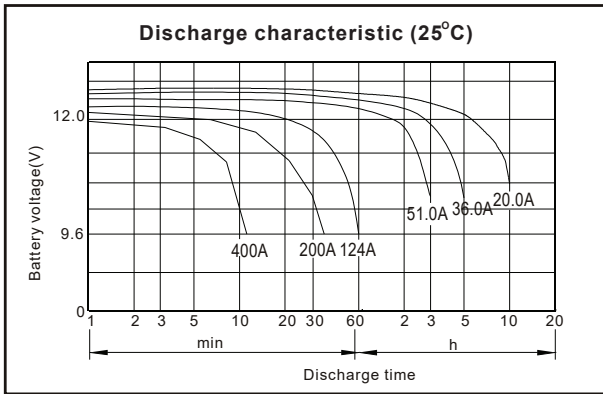

6FM200SE-X 12V 200Ah(10hr)

MAINTENANCE-FREE
RECHARGEABLE
SEALED LEAD ACID BATTERY

Overview

The rechargeable batteries are lead- lead dioxide systems. The dilute sulfuric acid electrolyte is absorbed by separators and plates and thus immobilized. Should the battery be accidentally overcharged producing hydrogen and oxygen, special oneway valves allow the gases to escape thus avoiding excessive pressure build-up. Otherwise, the battery is completely sealed and is, therefore, maintenance-free, leak proof and usable in any position.

Battery Construction

Component	Positive plate	Negative plate	Container	Cover	Safety valve	Terminal	Separator	Electrolyte
Raw material	Lead dioxide	Lead	ABS	ABS	Rubber	Copper	Fiberglass	Sulfuric acid

General Features

- Absorbent Glass Mat (AGM) technology for efficient gas recombination of up to 99% and freedom from electrolyte maintenance or water adding.
- Not restricted for air transport-complies with IATA/ICAO Special Provision A67.
- UL-recognized component.
- Can be mounted in any orientation.
- Computer designed lead, calcium tin alloy grid for high power density.
- Long service life, float or cyclic applications.
- Maintenance-free operation
- Low self discharge.
- Case and cover available in both standard and flame retardant ABS.

Dimensions and Weight

Length(mm / inch)	522 / 20.55
Width(mm / inch)	238 / 9.37
Height(mm / inch)	218 / 8.58
Total Height(mm / inch)	223 / 8.78
Approx. Weight(Kg / lbs)	59.1 / 130

* Weight deviation: ± 5%

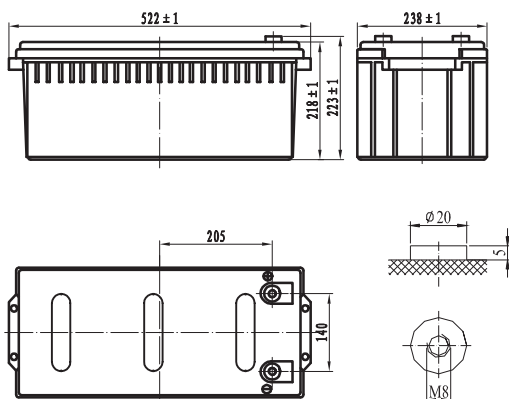

Battery Specification

Performance Characteristics	
Nominal Voltage	12V
Number of cell	6
Design Life	10 years
Nominal Capacity 77°F(25°C)	
10 hour rate (20.0A, 10.8V)	200Ah
5 hour rate (34.7A, 10.5V)	173.5Ah
1 hour rate (129A, 9.6V)	129Ah
Internal Resistance	
Fully Charged battery 77°F(25°C)	≤4.0mOhms
Self-Discharge	
3% of capacity declined per month at 20°C(average)	
Operating Temperature Range	
Discharge	-20~60°C
Charge	-10~60°C
Storage	-20~60°C
Max. Discharge Current 77°F(25°C)	1000A(5s)
Short Circuit Current	3300A
Charge Methods: Constant Voltage Charge 77°F(25°C)	
Cycle use	2.40-2.45VPC
Maximum charging current	60.0A
Temperature compensation	-30mV/°C
Standby use	2.20-2.28VPC
Temperature compensation	-20mV/°C

Discharge Constant Current (Amperes at 77°F25°C)

End Point								
Volts/Cell	10min	15min	30min	1h	3h	5h	10h	20h
1.60V	--	--	196	129	50.3	36.9	21.1	10.70
1.65V	--	--	188	126	49.1	36.2	20.9	10.65
1.70V	--	--	181	123	48.2	35.4	20.7	10.60
1.75V	--	--	175	120	47.1	34.7	20.4	10.55
1.80V	--	--	168	117	45.7	33.9	20.0	10.50

Discharge Constant Power (Watts at 77°F25°C)

End Point								
Volts/Cell	10min	15min	30min	45min	1h	2h	3h	5h
1.60V	--	--	374	268	248	137	97.4	70.3
1.65V	--	--	360	262	243	134	96.1	69.7
1.70V	--	--	347	257	238	131	94.8	69.1
1.75V	--	--	332	252	233	128	93.4	68.6
1.80V	--	--	319	247	228	124	92.4	68.1

(Note)The above characteristics data are average values obtained within three charge/discharge cycles not the minimum values.All data shall be changed without notice,AMB reserves the right to explain and update the information contained hereinto.

6FM200SE-X 12V 200Ah(10hr)

MAINTENANCE-FREE
RECHARGEABLE
SEALED LEAD ACID BATTERY

